

НОВИНКА



Жилой сектор



Гражданское применение



Промышленное применение



Пожаротушение

PVT/PVS

Вертикальный многоступенчатый насос из нержавеющей стали S.S.304



PVT



PVS



PVT

НОВИНКА

ОПИСАНИЕ

- ◆ Вертикальный многоступенчатый центробежный насос из нержавеющей стали 304
- ◆ Патрубки всасывания и нагнетания расположены в линию
- ◆ Головка и основание насоса PVT изготовлены из чугунного литья
- ◆ У насоса PVT из нержавеющей стали изготовлено рабочее колесо и вал
- ◆ У насоса PVS из нержавеющей стали изготовлены все смачиваемые детали
- ◆ Двигатель YE3 с высоким КПД и степенью защиты IP55 класс F
- ◆ Высококачественный подшипник, износостойкое механическое уплотнение
- ◆ Температура жидкости от -10°C до $+120^{\circ}\text{C}$

ОБЛАСТИ ПРИМЕНЕНИЯ

Многоступенчатые насосы из нержавеющей стали предназначены для промышленных систем обработки, промывки и очистки, для перекачки слабых растворов кислот и щелочей, для систем фильтрации, повышения давления воды, водоподготовки, для систем отопления, вентиляции и кондиционирования, для ирригации, для противопожарных систем и т.д.

КОД МОДЕЛИ

Например

PVT(S) 32 - 30 - 2

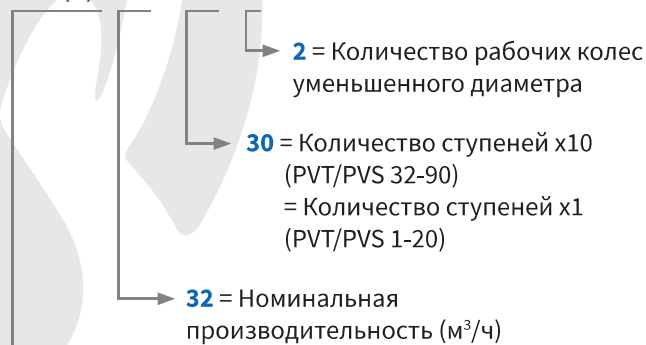

PVT = Вертикальный многоступенчатый насос
PVS = Вертикальный многоступенчатый насос с компонентами проточной части из нержавеющей стали 304

50 Гц

n=2900 об/мин

МОДЕЛЬ	DN	Мощность		галл. США/ мин 1,8	Q = ПРОИЗВОДИТЕЛЬНОСТЬ															
					л/мин 7	2,6	3,5	4,4	5,3	6,2	7	7,9	8,8	10,6	12,3	13,2	14,1	15,4	15,9	17,6
мм	кВт	л.с.	H = Высота напора (м)																	
PVT 1-2	25x25	0,37	0,5	13	12,5	12	11,5	11	10,5	10	9,5	9	-	-	-	-	-	-	-	
PVT 1-3	25x25	0,37	0,5	19	18	17,5	17	16,5	16	15	14	12	-	-	-	-	-	-	-	
PVT 1-4	25x25	0,37	0,5	24	23,5	23	22,5	21,5	21	19	18	16	-	-	-	-	-	-	-	
PVT 1-5	25x25	0,37	0,5	30	29,6	29	28	27	26	24	22	20	-	-	-	-	-	-	-	
PVT 1-6	25x25	0,37	0,5	36	35,5	35	33,5	33	31	28	26	23	-	-	-	-	-	-	-	
PVT 1-7	25x25	0,37	0,5	42	41	40,5	39	38	36	33	30	21	-	-	-	-	-	-	-	
PVT 1-8	25x25	0,55	0,75	48	47	46	45	43	41	38	34	30	-	-	-	-	-	-	-	
PVT 1-9	25x25	0,55	0,75	54	53	52	51	49	46	43	39	33	-	-	-	-	-	-	-	
PVT 1-10	25x25	0,55	0,75	60	59	58	57	54	51	48	43	36	-	-	-	-	-	-	-	
PVT 1-11	25x25	0,55	0,75	66	65	63	61	59	56	52	47	40	-	-	-	-	-	-	-	
PVT 1-12	25x25	0,75	1	72	71	69	67	64	61	57	51	44	-	-	-	-	-	-	-	
PVT 1-13	25x25	0,75	1	78	77	75	73	69	66	62	55	47	-	-	-	-	-	-	-	
PVT 1-15	25x25	0,75	1	89	88	86	84	79	76	71	63	55	-	-	-	-	-	-	-	
PVT 1-17	25x25	1,1	1,5	101	99	97	95	89	86	80	71	62	-	-	-	-	-	-	-	
PVT 1-19	25x25	1,1	1,5	113	110	108	106	99	96	89	79	69	-	-	-	-	-	-	-	
PVT 1-21	25x25	1,1	1,5	124	122	120	117	110	106	98	87	75	-	-	-	-	-	-	-	
PVT 1-23	25x25	1,1	1,5	137	133	131	128	121	116	107	96	82	-	-	-	-	-	-	-	
PVT 1-25	25x25	1,5	2	149	145	143	139	131	126	116	104	89	-	-	-	-	-	-	-	
PVT 1-27	25x25	1,5	2	161	157	155	150	141	136	125	112	95	-	-	-	-	-	-	-	
PVT 1-30	25x25	1,5	2	178	175	171	166	157	150	139	124	106	-	-	-	-	-	-	-	
PVT 1-33	25x25	2,2	3	196	192	188	183	173	165	154	137	118	-	-	-	-	-	-	-	
PVT 1-36	25x25	2,2	3	214	210	205	200	190	181	169	151	130	-	-	-	-	-	-	-	
PVT 2-2	25x25	0,37	0,5	-	-	-	18	17	17	16	16	15	13	12	11	10	8	-	-	
PVT 2-3	25x25	0,37	0,5	-	-	-	27	26	25	24	23	22	20	18	17	15	12	-	-	
PVT 2-4	25x25	0,55	0,75	-	-	-	36	35	34	33	32	30	26	24	22	20	16	-	-	
PVT 2-5	25x25	0,55	0,75	-	-	-	45	43	42	40	39	37	33	30	27	24	20	-	-	
PVT 2-6	25x25	0,75	1	-	-	-	53	52	51	50	48	45	40	36	33	30	24	-	-	
PVT 2-7	25x25	0,75	1	-	-	-	63	61	59	57	55	52	47	41	38	35	28	-	-	
PVT 2-9	25x25	1,1	1,5	-	-	-	80	78	76	73	70	67	61	54	50	45	37	-	-	
PVT 2-11	25x25	1,1	1,5	-	-	-	98	95	92	89	86	82	73	64	59	54	44	-	-	
PVT 2-13	25x25	1,5	2	-	-	-	116	114	110	106	102	98	89	78	72	65	52	-	-	
PVT 2-15	25x25	1,5	2	-	-	-	134	130	127	123	118	112	100	90	82	73	60	-	-	
PVT 2-18	25x25	2,2	3	-	-	-	161	157	153	148	142	136	121	108	100	91	76	-	-	
PVT 2-22	25x25	2,2	3	-	-	-	197	192	186	180	173	165	148	130	120	110	90	-	-	
PVT 2-26	25x25	3	4	-	-	-	232	228	221	214	206	198	179	158	144	130	110	-	-	
PVT 3-2	25x25	0,37	0,5	-	-	-	-	12,5	12	11,5	11	11	10,5	10	9	8	7	7	6	
PVT 3-3	25x25	0,37	0,5	-	-	-	-	19	19	18,5	18	17,5	16,5	15	14	13	12	11	9	
PVT 3-4	25x25	0,37	0,5	-	-	-	-	25	25	24	24	23	21,5	20	19	18	16	15	12	
PVT 3-5	25x25	0,37	0,5	-	-	-	-	31	31	30	30	29	27	25	23	22	20	19	16	
PVT 3-6	25x25	0,55	0,75	-	-	-	-	36	36	35	35	34	32	30	28	27	24	23	19	
PVT 3-7	25x25	0,55	0,75	-	-	-	-	43	42	41	40	39	37	34	32	31	28	21	22	
PVT 3-8	25x25	0,75	1	-	-	-	-	49	48	47	46	45	43	39	37	35	32	31	25	
PVT 3-9	25x25	0,75	1	-	-	-	-	55	54	53	52	51	48	45	42	40	36	35	28	
PVT 3-10	25x25	0,75	1	-	-	-	-	61	60	59	58	57	54	50	47	45	41	39	31	
PVT 3-11	25x25	1,1	1,5	-	-	-	-	67	66	64	63	61	58	54	51	49	44	42	34	
PVT 3-12	25x25	1,1	1,5	-	-	-	-	73	72	70	69	67	63	58	55	52	47	45	37	
PVT 3-13	25x25	1,1	1,5	-	-	-	-	78	77	76	75	73	69	64	60	57	51	49	40	
PVT 3-15	25x25	1,1	1,5	-	-	-	-	90	89	88	86	84	79	73	69	66	59	57	46	
PVT 3-17	25x25	1,5	2	-	-	-	-	103	102	100	98	96	90	83	79	75	67	64	52	
PVT 3-19	25x25	1,5	2	-	-	-	-	115	114	112	110	107	100	92	88	83	75	72	58	
PVT 3-21	25x25	2,2	3	-	-	-	-	128	126	124	122	119	112	102	98	91	82	79	64	
PVT 3-23	25x25	2,2	3	-	-	-	-	140	138	135	133	130	122	112	107	100	90	86	70	
PVT 3-25	25x25	2,2	3	-	-	-	-	151	149	147	144	141	131	122	116	109	98	94	76	
PVT 3-27	25x25	2,2	3	-	-	-	-	164	162	159	156	152	143	132	124	117	105	101	82	
PVT 3-29	25x25	2,2	3	-	-	-	-	175	173	170	167	163	153	142	133	126	113	109	88	
PVT 3-31	25x25	3	4	-	-	-	-	187	185	182	179	175	165	153	142	135	121	116	94	
PVT 3-33	25x25	3	4	-	-	-	-	199	197	194	191	187	176	163	151	145	130	125	100	
PVT 3-36	25x25	3	4	-	-	-	-	218	215	212	208	204	192	178	168	159	143	137	109	

Также доступно исполнение PVS

Кривую производительности см. на стр. 9

50 Гц n=2900 об/мин

МОДЕЛЬ	DN	Мощность		Q = ПРОИЗВОДИТЕЛЬНОСТЬ																
				галл. США/ мин 6,6	8,8	13,2	17,6	22	26,4	30,8	35,2	39,6	44,1	48,5	52,9	57,3	61,7	66,1	70,5	
				л/мин 25	33	50	67	83	100	117	133	150	167	183	200	217	233	250	267	
				м³/ч 1,5	2	3	4	5	6	7	8	9	10	11	12	13	14	15	16	
мм		кВт	л.с.	H = Высота напора (м)																
PVT 4-2	32x32	0,37	0,5	19	18	17	15	13	10	8	-	-	-	-	-	-	-	-	-	
PVT 4-3	32x32	0,55	0,75	28	27	26	24	20	18	13	-	-	-	-	-	-	-	-	-	
PVT 4-4	32x32	0,75	1	38	36	34	32	27	24	19	-	-	-	-	-	-	-	-	-	
PVT 4-5	32x32	1,1	1,5	47	45	43	40	34	31	23	-	-	-	-	-	-	-	-	-	
PVT 4-6	32x32	1,1	1,5	56	54	52	48	41	37	28	-	-	-	-	-	-	-	-	-	
PVT 4-7	32x32	1,5	2	66	63	61	56	48	43	33	-	-	-	-	-	-	-	-	-	
PVT 4-8	32x32	1,5	2	74	72	70	64	55	50	38	-	-	-	-	-	-	-	-	-	
PVT 4-10	32x32	2,2	3	96	90	87	81	71	62	48	-	-	-	-	-	-	-	-	-	
PVT 4-12	32x32	2,2	3	114	108	104	95	85	75	58	-	-	-	-	-	-	-	-	-	
PVT 4-14	32x32	3	4	136	126	122	112	101	89	68	-	-	-	-	-	-	-	-	-	
PVT 4-16	32x32	3	4	152	144	140	129	115	101	78	-	-	-	-	-	-	-	-	-	
PVT 4-19	32x32	4	5,5	183	171	168	153	137	122	93	-	-	-	-	-	-	-	-	-	
PVT 4-22	32x32	4	5,5	211	200	192	178	160	138	108	-	-	-	-	-	-	-	-	-	
PVT 8-2-1	40x40	0,75	1	-	-	-	-	10	9,5	9,3	9	8,5	8	7	6	-	-	-	-	
PVT 8-2	40x40	0,75	1	-	-	-	-	20	19,5	19	18	17	16	14	13	-	-	-	-	
PVT 8-3	40x40	1,1	1,5	-	-	-	-	30	29,5	28,5	27	25	24	21	19	-	-	-	-	
PVT 8-4	40x40	1,5	2	-	-	-	-	41	39,5	38	36	34	32	28	26	-	-	-	-	
PVT 8-5	40x40	2,2	3	-	-	-	-	52	50	48	45	42	40	36	32	-	-	-	-	
PVT 8-6	40x40	2,2	3	-	-	-	-	62	60	57	54	51	48	43	39	-	-	-	-	
PVT 8-8	40x40	3	4	-	-	-	-	83	80	77	73	69	65	58	52	-	-	-	-	
PVT 8-10	40x40	4	5,5	-	-	-	-	104	100	97	92	87	81	73	65	-	-	-	-	
PVT 8-12	40x40	4	5,5	-	-	-	-	124	120	116	111	104	92	87	78	-	-	-	-	
PVT 8-14	40x40	5,5	7,5	-	-	-	-	145	141	136	130	122	113	102	92	-	-	-	-	
PVT 8-16	40x40	5,5	7,5	-	-	-	-	166	161	156	148	139	130	118	106	-	-	-	-	
PVT 8-18	40x40	7,5	10	-	-	-	-	187	182	175	167	157	146	134	120	-	-	-	-	
PVT 8-20	40x40	7,5	10	-	-	-	-	208	202	195	186	175	163	150	135	-	-	-	-	
PVT 10-1	40x40	0,75	1	-	-	-	-	9,7	9,3	8,9	8,3	7,7	7	6	5	4	-	-	-	
PVT 10-2	40x40	0,75	1	-	-	-	-	19,5	19	18	17	16	15	13,5	11,5	10	-	-	-	
PVT 10-3	40x40	1,1	1,5	-	-	-	-	29,5	29	28	27	25	23	21	18	16	-	-	-	
PVT 10-4	40x40	1,5	2	-	-	-	-	39,5	38,5	37,5	36	34	31	28	25	22	-	-	-	
PVT 10-5	40x40	2,2	3	-	-	-	-	49,5	48,5	47	44	42	39	35	32	28	-	-	-	
PVT 10-6	40x40	2,2	3	-	-	-	-	60	58	56	54	51	48	43	39	34	-	-	-	
PVT 10-7	40x40	3	4	-	-	-	-	70	68	66	63	60	56	51	45	39	-	-	-	
PVT 10-8	40x40	3	4	-	-	-	-	80	78	75	73	69	64	58	52	44	-	-	-	
PVT 10-9	40x40	3	4	-	-	-	-	90	87	85	81	77	72	66	58	50	-	-	-	
PVT 10-10	40x40	4	5,5	-	-	-	-	100	97	95	90	85	80	74	66	56	-	-	-	
PVT 10-12	40x40	4	5,5	-	-	-	-	120	117	114	109	104	96	89	79	68	-	-	-	
PVT 10-14	40x40	5,5	7,5	-	-	-	-	140	137	134	129	122	113	103	92	79	-	-	-	
PVT 10-16	40x40	5,5	7,5	-	-	-	-	160	158	153	148	140	129	119	106	91	-	-	-	
PVT 10-18	40x40	7,5	10	-	-	-	-	180	177	172	166	156	145	133	119	102	-	-	-	
PVT 10-20	40x40	7,5	10	-	-	-	-	200	196	191	184	173	162	147	132	114	-	-	-	
PVT 10-22	40x40	7,5	10	-	-	-	-	220	216	210	202	190	178	162	145	126	-	-	-	
PVT 12-2	50x50	1,5	2	-	-	-	-	-	23,5	23	22,5	22	21	20	18,5	17	15,5	14		
PVT 12-3	50x50	2,2	3	-	-	-	-	-	35,5	35	34	33	31,5	30	28	26	23,5	21		
PVT 12-4	50x50	3	4	-	-	-	-	-	47	46	45	44	42	40	37	34	31	28		
PVT 12-5	50x50	3	4	-	-	-	-	-	59,5	58	56,5	55	52,5	50	46,5	43	39	35		
PVT 12-6	50x50	4	5,5	-	-	-	-	-	71,5	70	68	66	63	60	56	52	47	42		
PVT 12-7	50x50	5,5	7,5	-	-	-	-	-	83,5	82	79,5	77	73,5	70	65,5	61	55	49		
PVT 12-8	50x50	5,5	7,5	-	-	-	-	-	95,5	94	91	88	84	80	75	70	63	56		
PVT 12-9	50x50	5,5	7,5	-	-	-	-	-	108	106	103	100	95,5	91	85	79	71,5	64		
PVT 12-10	50x50	7,5	10	-	-	-	-	-	120	118	114,5	111	106	101	94,5	88	80	72		
PVT 12-12	50x50	7,5	10	-	-	-	-	-	143,5	141	137	133	127	121	113,5	106	96	86		
PVT 12-14	50x50	11	15	-	-	-	-	-	168	165	160	155	148	141	132,5	124	112	100		
PVT 12-16	50x50	11	15	-	-	-	-	-	192,5	189	183,5	178	170	162	152	142	128,5	115		
PVT 12-18	50x50	11	15	-	-	-	-	-	217	213	207,5	202	192,5	183	171,5	160	145	130		

Также доступно исполнение PVS

Кривую производительности см. на стр. 10

50 Гц n=2900 об/мин

МОДЕЛЬ	DN мм	Мощность кВт л.с.		Q = ПРОИЗВОДИТЕЛЬНОСТЬ															
				галл. США/ мин 35	44	53	62	70	79	88	97	106	115	123	141	159	176		
				л/мин 133	167	200	233	267	300	333	367	400	433	467	533	600	667		
				м³/ч 8	10	12	14	16	18	20	22	24	26	28	32	36	40		
H = Высота напора (м)																			
PVT 16-2	50x50	2,2	3	27	26	25	24	22	21	19	16	-	-	-	-	-	-		
PVT 16-3	50x50	3	4	41	40	38	37	34	32	29	25	-	-	-	-	-	-		
PVT 16-4	50x50	4	5,5	54	53	52	49	46	43	38	34	-	-	-	-	-	-		
PVT 16-5	50x50	5,5	7,5	68	67	65	62	58	54	48	43	-	-	-	-	-	-		
PVT 16-6	50x50	5,5	7,5	82	80	78	74	70	64	58	52	-	-	-	-	-	-		
PVT 16-7	50x50	7,5	10	96	95	91	87	82	76	68	61	-	-	-	-	-	-		
PVT 16-8	50x50	7,5	10	110	108	104	99	94	86	71	70	-	-	-	-	-	-		
PVT 16-10	50x50	11	15	138	136	131	125	118	109	97	87	-	-	-	-	-	-		
PVT 16-12	50x50	11	15	166	162	157	150	141	130	116	105	-	-	-	-	-	-		
PVT 16-14	50x50	15	20	194	190	184	175	166	152	136	122	-	-	-	-	-	-		
PVT 16-16	50x50	15	20	222	217	210	200	189	174	156	140	-	-	-	-	-	-		
PVT 20-1	50x50	1,1	1,5	-	13,5	13	12,5	12	11	10	9	8	7	6	-	-	-		
PVT 20-2	50x50	2,2	3	-	27	26,5	26	25	24	23	22	20	18	15	-	-	-		
PVT 20-3	50x50	4	5,5	-	40	39,5	39	38	37	35	33	30	27	24	-	-	-		
PVT 20-4	50x50	5,5	7,5	-	54	53	52	51	49	47	44	41	37	33	-	-	-		
PVT 20-5	50x50	5,5	7,5	-	67	66	64	62	60	58	55	50	45	40	-	-	-		
PVT 20-6	50x50	7,5	10	-	81	79	77	75	73	70	66	61	55	49	-	-	-		
PVT 20-7	50x50	7,5	10	-	95	93	91	89	86	82	77	71	65	58	-	-	-		
PVT 20-8	50x50	11	15	-	109	107	105	102	99	94	89	82	75	67	-	-	-		
PVT 20-10	50x50	11	15	-	136	134	131	128	124	118	111	103	95	85	-	-	-		
PVT 20-12	50x50	15	20	-	164	162	158	154	149	142	133	124	114	102	-	-	-		
PVT 20-14	50x50	15	20	-	192	189	185	180	174	166	156	145	133	119	-	-	-		
PVT 20-17	50x50	18,5	25	-	234	230	225	219	212	202	190	177	162	145	-	-	-		
PVT 32-10-1	65x65	1,5	2	-	-	-	-	14	14	13	13	12	12	11	9	7	4		
PVT 32-10	65x65	2,2	3	-	-	-	-	18	18	17	16	15	15	14	13	11	8		
PVT 32-20-2	65x65	3	4	-	-	-	-	29	29	28	27	26	25	23	20	16	11		
PVT 32-20	65x65	4	5,5	-	-	-	-	36	35	34	33	32	31	29	27	23	18		
PVT 32-30-2	65x65	5,5	7,5	-	-	-	-	47	46	44	43	41	40	38	33	28	21		
PVT 32-30	65x65	5,5	7,5	-	-	-	-	54	53	51	50	48	46	44	40	35	27		
PVT 32-40-2	65x65	7,5	10	-	-	-	-	65	64	62	60	58	56	53	46	40	30		
PVT 32-40	65x65	7,5	10	-	-	-	-	72	71	69	67	65	62	59	53	47	37		
PVT 32-50-2	65x65	11	15	-	-	-	-	83	81	79	77	74	71	68	60	52	41		
PVT 32-50	65x65	11	15	-	-	-	-	90	88	86	84	81	78	74	67	59	47		
PVT 32-60-2	65x65	11	15	-	-	-	-	101	99	97	94	90	87	83	74	65	51		
PVT 32-60	65x65	11	15	-	-	-	-	108	106	104	101	97	94	90	81	72	57		
PVT 32-70-2	65x65	15	20	-	-	-	-	119	117	114	111	107	103	98	88	78	60		
PVT 32-70	65x65	15	20	-	-	-	-	126	124	121	117	113	109	105	95	85	67		
PVT 32-80-2	65x65	15	20	-	-	-	-	136	134	131	127	123	119	114	102	90	71		
PVT 32-80	65x65	15	20	-	-	-	-	144	141	138	134	130	125	120	109	97	77		
PVT 32-90-2	65x65	18,5	25	-	-	-	-	154	151	148	144	140	135	129	117	102	82		
PVT 32-90	65x65	18,5	25	-	-	-	-	162	159	156	152	147	142	136	124	109	88		
PVT 32-100-2	65x65	18,5	25	-	-	-	-	175	171	166	162	157	152	146	131	115	91		
PVT 32-100	65x65	18,5	25	-	-	-	-	182	178	173	169	164	158	152	138	122	98		
PVT 32-110-2	65x65	22	30	-	-	-	-	193	189	184	179	173	169	164	146	128	102		
PVT 32-110	65x65	22	30	-	-	-	-	200	196	191	186	180	174	168	153	135	109		
PVT 32-120-2	65x65	22	30	-	-	-	-	211	206	201	195	189	184	178	160	140	113		
PVT 32-120	65x65	22	30	-	-	-	-	218	213	208	202	196	190	184	167	147	120		
PVT 32-130-2	65x65	30	40	-	-	-	-	230	224	218	212	206	200	193	174	153	124		
PVT 32-130	65x65	30	40	-	-	-	-	237	231	225	219	213	207	200	181	160	131		
PVT 32-140-2	65x65	30	40	-	-	-	-	247	241	235	229	222	216	210	189	165	135		
PVT 32-140	65x65	30	40	-	-	-	-	255	249	242	236	229	223	216	196	172	142		
PVT 32-150-2	65x65	30	40	-	-	-	-	266	260	253	246	239	232	224	203	178	145		
PVT 32-150	65x65	30	40	-	-	-	-	274	267	260	253	246	239	231	210	185	152		
PVT 32-160-2	65x65	30	40	-	-	-	-	284	277	270	263	255	248	240	218	190	156		
PVT 32-160	65x65	30	40	-	-	-	-	292	285	277	270	262	254	246	225	197	163		

Также доступно исполнение PVS

Кривую производительности см. на стр. 11

50 Гц n=2900 об/мин

МОДЕЛЬ	DN мм	Мощность кВт л.с.		галл. США/ мин 110	Q = ПРОИЗВОДИТЕЛЬНОСТЬ																
				л/мин 417	132	154	176	185	198	220	242	264	286	308	352	374	396	441	485		
				м³/ч 25	500	583	667	700	750	833	917	1000	1083	1167	1333	1417	1500	1667	1833		
				H = Высота напора (м)																	
PVT 45-10-1	80x80	3	4	20	19	18	17	16	15	13	11	-	-	-	-	-	-	-			
PVT 45-10	80x80	4	5,5	24	23	22	21	20	19	18	16	-	-	-	-	-	-	-			
PVT 45-20-2	80x80	5,5	7,5	40	38	36	33	32	30	27	23	-	-	-	-	-	-	-			
PVT 45-20	80x80	7,5	10	48	46	44	42	41	39	35	31	-	-	-	-	-	-	-			
PVT 45-30-2	80x80	11	15	63	61	58	54	52	50	44	38	-	-	-	-	-	-	-			
PVT 45-30	80x80	11	15	71	69	66	63	61	58	53	47	-	-	-	-	-	-	-			
PVT 45-40-2	80x80	15	20	87	84	80	75	73	69	62	54	-	-	-	-	-	-	-			
PVT 45-40	80x80	15	20	95	92	88	84	81	78	71	62	-	-	-	-	-	-	-			
PVT 45-50-2	80x80	18,5	25	111	107	102	96	93	88	80	69	-	-	-	-	-	-	-			
PVT 45-50	80x80	18,5	25	119	115	110	105	101	97	88	78	-	-	-	-	-	-	-			
PVT 45-60-2	80x80	22	30	135	130	124	117	113	108	97	85	-	-	-	-	-	-	-			
PVT 45-60	80x80	22	30	143	138	132	125	122	116	106	93	-	-	-	-	-	-	-			
PVT 45-70-2	80x80	30	40	158	152	146	138	134	127	115	100	-	-	-	-	-	-	-			
PVT 45-70	80x80	30	40	166	161	154	146	142	135	124	109	-	-	-	-	-	-	-			
PVT 45-80-2	80x80	30	40	182	175	168	159	154	146	133	116	-	-	-	-	-	-	-			
PVT 45-80	80x80	30	40	190	184	176	167	162	154	141	124	-	-	-	-	-	-	-			
PVT 45-90-2	80x80	30	40	205	198	190	180	174	166	150	132	-	-	-	-	-	-	-			
PVT 45-90	80x80	37	50	214	207	198	188	183	174	159	140	-	-	-	-	-	-	-			
PVT 45-100-2	80x80	37	50	230	221	212	200	194	185	168	147	-	-	-	-	-	-	-			
PVT 45-100	80x80	37	50	238	230	220	209	203	193	177	155	-	-	-	-	-	-	-			
PVT 45-110-2	80x80	45	60	255	246	236	223	217	206	188	165	-	-	-	-	-	-	-			
PVT 45-110	80x80	45	60	263	255	244	232	225	214	196	173	-	-	-	-	-	-	-			
PVT 45-120-2	80x80	45	60	280	270	259	245	238	226	206	181	-	-	-	-	-	-	-			
PVT 45-120	80x80	45	60	289	280	268	255	247	236	216	190	-	-	-	-	-	-	-			
PVT 45-130-2	80x80	45	60	305	294	282	267	259	247	225	198	-	-	-	-	-	-	-			
PVT 64-10-1	100x100	4	5,5	-	19	19	18	18	17	16	15	14	13	11	8	-	-	-			
PVT 64-10	100x100	5,5	7,5	-	27	26	25	25	24	23	22	21	20	18	15	-	-	-			
PVT 64-20-2	100x100	7,5	10	-	39	38	36	36	35	33	31	29	26	23	17	-	-	-			
PVT 64-20-1	100x100	11	15	-	46	45	44	43	42	40	38	36	33	30	24	-	-	-			
PVT 64-20	100x100	11	15	-	53	52	51	50	49	47	45	43	40	37	30	-	-	-			
PVT 64-30-2	100x100	15	20	-	66	64	62	61	59	56	53	50	46	41	32	-	-	-			
PVT 64-30-1	100x100	15	20	-	73	71	69	68	66	63	60	57	53	48	39	-	-	-			
PVT 64-30	100x100	18,5	25	-	80	78	76	75	73	70	67	64	60	55	46	-	-	-			
PVT 64-40-2	100x100	18,5	25	-	92	90	87	86	84	80	76	71	66	60	47	-	-	-			
PVT 64-40-1	100x100	22	30	-	100	97	94	93	91	87	83	78	73	67	54	-	-	-			
PVT 64-40	100x100	22	30	-	107	104	101	100	98	94	90	85	80	74	61	-	-	-			
PVT 64-50-2	100x100	30	40	-	121	118	114	112	110	105	100	95	88	80	64	-	-	-			
PVT 64-50-1	100x100	30	40	-	128	125	121	119	117	112	107	102	95	87	71	-	-	-			
PVT 64-50	100x100	30	40	-	136	133	129	127	124	119	114	109	102	94	78	-	-	-			
PVT 64-60-2	100x100	30	40	-	150	146	142	140	137	131	125	118	110	101	81	-	-	-			
PVT 64-60-1	100x100	37	50	-	157	153	149	147	144	138	132	125	117	108	88	-	-	-			
PVT 64-60	100x100	37	50	-	164	160	156	154	151	145	139	132	124	115	95	-	-	-			
PVT 64-70-2	100x100	37	50	-	179	174	169	167	163	156	149	141	132	121	99	-	-	-			
PVT 64-70-1	100x100	37	50	-	186	181	176	174	170	163	156	148	139	128	106	-	-	-			
PVT 64-70	100x100	45	60	-	193	188	183	181	177	170	163	155	146	135	112	-	-	-			
PVT 64-80-2	100x100	45	60	-	207	202	196	193	189	182	173	164	154	142	116	-	-	-			
PVT 64-80-1	100x100	45	60	-	215	209	203	200	196	189	180	171	161	149	123	-	-	-			
PVT 90-10-1	100x100	5,5	7,5	-	-	-	-	-	-	22	21	19	18	17	16	14	13	10	6		
PVT 90-10	100x100	7,5	10	-	-	-	-	-	-	25	25	24	23	22	21	20	19	16	12		
PVT 90-20-2	100x100	11	15	-	-	-	-	-	-	41	40	39	38	36	32	30	28	22	15		
PVT 90-20	100x100	15	20	-	-	-	-	-	-	53	52	50	49	47	44	41	40	36	30		
PVT 90-30-2	100x100	18,5	25	-	-	-	-	-	-	68	67	65	63	60	55	52	49	41	32		
PVT 90-30	100x100	22	30	-	-	-	-	-	-	81	79	77	75	72	67	64	62	55	48		
PVT 90-40-2	100x100	30	40	-	-	-	-	-	-	98	96	93	90	87	80	75	72	62	50		
PVT 90-40	100x100	30	40	-	-	-	-	-	-	110	108	105	103	100	92	86	84	76	66		
PVT 90-50-2	100x100	37	50	-	-	-	-	-	-	126	123	120	117	113	104	98	93	81	68		
PVT 90-50	100x100	37	50	-	-	-	-	-	-	139	135	131	128	124	115	110	106	94	83		
PVT 90-60-2	100x100	45	60	-	-	-	-	-	-	155	152	148	144	139	129	122	117	102	86		
PVT 90-60	100x100	45	60	-	-	-	-	-	-	168	164	160	155	150	141	134	130	117	103		

Также доступно исполнение PVS

Кривую производительности см. на стр. 11-13

ОПИСАНИЕ МАТЕРИАЛА

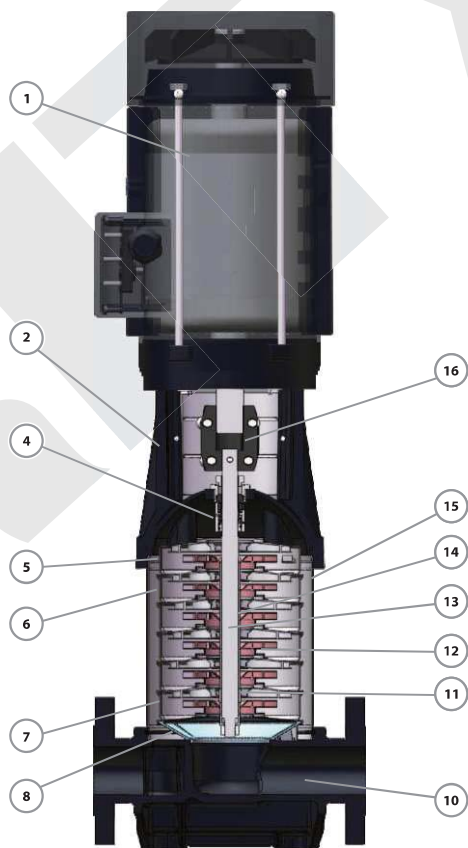

PVT

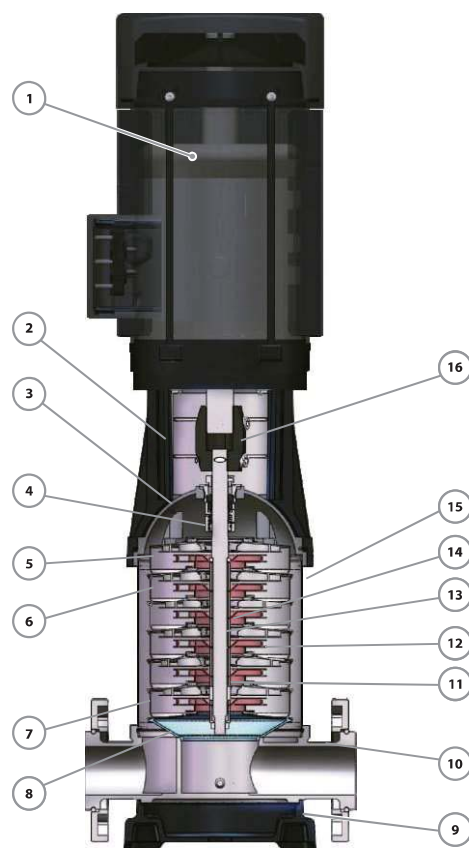

PVS

№	Описание	Материал
1	Двигатель	IP55 класс F
2	Корпус насоса	Чугун
3	Основание уплотнения	Нержавеющая сталь 304
4	Механическое уплотнение	Нержавеющая сталь 304
5	Верхний диффузор	Нержавеющая сталь 304
6	Диффузор	Нержавеющая сталь 304
7	Опора диффузора	Нержавеющая сталь 304
8	Шнек	Нержавеющая сталь 304

№	Описание	Материал
9	Опорная плита	Чугун
10	Входная и выходная камера	PVT: Чугун PVS: Нержавеющая сталь 304
11	Подшипник	Карбид вольфрама
12	Рабочее колесо	Нержавеющая сталь 304
13	Вал	Нержавеющая сталь 304
14	Втулка рабочего колеса	Нержавеющая сталь 304
15	Цилиндр	Нержавеющая сталь 304
16	Муфта	Углеродистая сталь

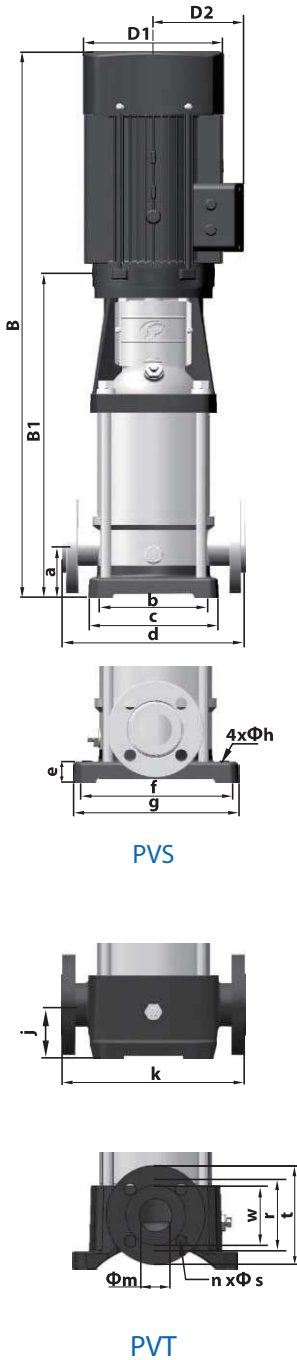

PVS

PVT

МОДЕЛЬ	B1	B	D1	D2	ОБЩ.	кг
1-2	258	483	148	117	DN=25 a=50 b=100 c=150 d=250 e=20 f=180 g=210 h=13 j=75 k=250 m=32 n=4 r=85 s=14 t=115 w=60	20
1-3	276	501	148	117		20
1-4	294	519	148	117		21
1-5	312	537	148	117		21
1-6	330	555	148	117		22
1-7	348	573	148	117		23
1-8	366	591	148	117		24
1-9	384	609	148	117		25
1-10	402	627	148	117		26
1-11	420	645	148	117		26
1-12	448	693	170	142		29
1-13	466	711	170	142		30
1-15	502	747	170	142		31
1-17	538	783	170	142		33
1-19	574	819	170	142		34
1-21	610	855	170	142		35
1-23	646	891	170	142		36
1-25	692	982	190	155		42
1-27	728	1018	190	155		43
1-30	782	1072	190	155		45
1-33	836	1126	190	155		49
1-36	890	1180	190	155		51
2-2	258	483	148	117		20
2-3	276	501	148	117		20
2-4	294	519	148	117		22
2-5	312	537	148	117		23
2-6	340	585	170	142		26
2-7	358	603	170	142		26
2-9	394	639	170	142		28
2-11	430	675	170	142		29
2-13	476	766	190	155		35
2-15	512	802	190	155		36
2-18	566	856	190	155		41
2-22	638	928	190	155		42
2-26	720	1065	197	165		52
3-2	258	483	148	117		20
3-3	276	501	148	117	20	
3-4	294	519	148	117	21	
3-5	312	537	148	117	21	
3-6	330	555	148	117	23	
3-7	348	573	148	117	24	
3-8	376	621	170	142	27	
3-9	394	639	170	142	28	
3-10	412	657	170	142	28	
3-11	430	675	170	142	29	
3-12	448	693	170	142	30	
3-13	466	711	170	142	31	
3-15	502	747	170	142	32	
3-17	548	838	190	155	38	
3-19	584	874	190	155	39	
3-21	620	910	190	155	42	
3-23	656	946	190	155	43	
3-25	692	982	190	155	44	
3-27	728	1018	190	155	45	
3-29	764	1054	190	155	46	
3-31	810	1155	197	165	54	
3-33	846	1191	197	165	55	
3-36	900	1245	197	165	57	

МОДЕЛЬ	B1	B	D1	D2	ОБЩ.	кг
4-2	276	501	148	117	DN=32 a=50 b=100 c=150 d=250 e=20 f=180 g=210 h=13 j=75 k=250 m=32 n=4 r=100 s=18 t=140 w=60	21
4-3	303	528	148	117		22
4-4	340	585	170	142		25
4-5	367	612	170	142		Z1
4-6	394	639	170	142		27
4-7	431	721	190	155		33
4-8	458	748	190	155		33
4-10	512	802	190	155		37
4-12	566	856	190	155		38
4-14	630	975	197	165		46
4-16	684	1029	197	165		48
4-19	765	1120	230	188		57
4-22	846	1201	230	188		59
8-2-1	347	592	170	142		DN=40 a=80 b=130 c=199 d=280 e=25 f=215 g=247 h=14 j=80 k=280 m=50 n=4 r=110 s=18 t=150 w=80
8-2	347	592	170	142	32	
8-3	377	622	170	142	34	
8-4	417	707	190	155	40	
8-5	447	737	190	155	44	
8-6	477	767	190	155	45	
8-8	547	892	197	165	53	
8-10	607	962	230	188	64	
8-12	667	1022	230	188	66	
8-14	747	1137	260	208	81	
8-16	807	1197	260	208	84	
8-18	867	1257	260	208	93	
8-20	927	1317	260	208	94	
10-1	347	592	170	142	40	
10-2	347	592	170	142	41	
10-3	377	622	170	142	43	
10-4	417	707	190	155	49	
10-5	447	737	190	155	53	
10-6	477	767	190	155	54	
10-7	517	862	197	165	64	
10-8	547	892	197	165	65	
10-9	577	922	197	165	66	
10-10	607	962	230	188	74	
10-12	667	1022	230	188	76	
10-14	747	1137	260	208	100	
10-16	807	1197	260	208	102	
10-18	867	1257	260	208	107	
10-20	927	1317	260	208	109	
10-22	987	1377	260	208	111	
12-2	367	657	190	155	DN=50 a=90 b=130 c=199 d=300 e=35 f=215 g=247 h=14 j=90 k=300 m=50 n=4 r=125 s=18 t=165 w=80	39
12-3	397	687	190	155		43
12-4	437	782	197	165		51
12-5	467	812	197	165		53
12-6	497	852	230	188		61
12-7	547	937	260	208		73
12-8	577	967	260	208		74
12-9	607	997	260	208		76
12-10	637	1027	260	208		83
12-12	697	1087	260	208		87
12-14	845	1345	330	255		157
12-16	905	1405	330	255		161
12-18	965	1465	330	255		164

МОДЕЛЬ	B1	B	D1	D2	ОБЩ.	кг
16-2	397	687	190	155	DN=50 a=90 b=130 c=199 d=300 e=35 f=215 g=247 h=14 j=90 k=300 m=50 n=4 r=125 s=18 t=165 w=80	42
16-3	452	797	197	165		50
16-4	497	852	230	188		59
16-5	562	952	260	208		76
16-6	607	997	260	208		77
16-7	652	1042	260	208		84
16-8	697	1087	260	208		86
16-10	875	1375	330	255		158
16-12	965	1465	330	255		161
16-14	1055	1555	330	255		174
16-16	1145	1645	330	255		178
20-1	387	632	170	142		33
20-2	397	687	190	155		42
20-3	452	807	230	188		58
20-4	517	907	260	208		74
20-5	562	952	260	208		76
20-6	607	997	260	208		82
20-7	652	1042	260	208		84
20-8	785	1285	330	255		153
20-10	875	1375	330	255		157
20-12	965	1465	330	255	170	
20-14	1055	1555	330	255	172	
20-17	1190	1740	330	255	195	
32-10-1	505	795	190	155	DN=65 a=105 b=170 c=225 d=320 e=30 f=240 g=298 h=14 j=105 k=320 m=74 n=8 r=145 s=18 t=185 w=107	64
32-10	505	795	190	155		68
32-20-2	575	920	197	165		77
32-20	575	930	230	188		85
32-30-2	645	1035	260	208		100
32-30	645	1035	260	208		100
32-40-2	715	1105	260	208		109
32-40	715	1105	260	208		109
32-50-2	890	1390	330	255		181
32-50	890	1390	330	255		181
32-60-2	960	1460	330	255		185
32-60	960	1460	330	255		185
32-70-2	1030	1530	330	255		199
32-70	1030	1530	330	255		199
32-80-2	1100	1600	330	255		203
32-80	1100	1600	330	255		203
32-90-2	1170	1720	330	255		222
32-90	1170	1720	330	255		222
32-100-2	1240	1790	330	255		2T1
32-100	1240	1790	330	255		2T1
32-110-2	1310	1885	360	285		272
32-110	1310	1885	360	285		272
32-120-2	1380	1955	360	285		276
32-120	1380	1955	360	285		276
32-130-2	1450	2100	400	310		337
32-130	1450	2100	400	310		337
32-140-2	1520	2170	400	310		341
32-140	1520	2170	400	310		341
32-150-2	1590	2240	400	310		345
32-150	1590	2240	400	310		345
32-160-2	1660	2310	400	310		350
32-160	1660	2310	400	310		350

МОДЕЛЬ	B1	B	D1	D2	ОБЩ.	кг
45-10-1	561	906	197	165	DN=80 a=140 b=190 c=245 d=365 e=45 f=266 g=330 h=14 j=140 k=365 m=80 n=8 r=160 s=18 t=200 w=120	83
45-10	561	916	230	188		90
45-20-2	641	1031	260	208		105
45-20	641	1031	260	208		110
45-30-2	826	1326	330	255		183
45-30	826	1326	330	255		183
45-40-2	906	1406	330	255		197
45-40	906	1406	330	255		197
45-50-2	986	1536	330	255		221
45-50	986	1536	330	255		221
45-60-2	1066	1641	360	285		261
45-60	1066	1641	360	285		261
45-70-2	1146	1796	400	310		320
45-70	1146	1796	400	310		320
45-80-2	1226	1876	400	310		324
45-80	1226	1876	400	310		324
45-90-2	1306	1956	400	310		328
45-90	1306	1956	400	310		352
45-100-2	1386	2036	400	310		355
45-100	1386	2036	400	310		355
45-110-2	1466	2151	450	345	426	
45-110	1466	2151	450	345	426	
45-120-2	1546	2231	450	345	432	
45-120	1546	2231	450	345	432	
45-130-2	1626	2311	450	345	438	
64-10-1	561	916	230	188	DN=100 a=140 b=190 c=245 d=365 e=45 f=266 g=330 h=14 j=140 k=365 m=100 n=8 r=180 s=18 t=220 w=150	93
64-10	561	951	260	208		105
64-20-2	644	1034	260	208		110
64-20-1	754	1254	330	255		182
64-20	754	1254	330	255		182
64-30-2	836	1336	330	255		196
64-30-1	836	1336	330	255		197
64-30	836	1386	330	255		221
65-40-2	919	1469	330	255		225
64-40-1	919	1494	360	285		258
64-40	919	1494	360	285		258
64-50-2	1001	1651	400	310		319
64-50-1	1001	1651	400	310		319
64-50	1001	1651	400	310		320
64-60-2	1084	1734	400	310		325
64-60-1	1084	1734	400	310		349
64-60	1084	1734	400	310		349
64-70-2	1166	1816	400	310		353
64-70-1	1166	1816	400	310		353
64-70	1166	1851	460	340		420
64-80-2	1248	1933	460	340	424	
64-80-1	1248	1933	460	340	424	
90-10-1	571	961	260	208	DN=100 a=140 b=199 c=255 d=380 e=45 f=280 g=348 n=14 j=140 k=380 m=100 n=8 r=180 s=18 t=220 w=150	105
90-10	571	961	260	208		110
90-20-2	773	1273	330	255		181
90-20	773	1273	330	255		192
90-30-2	865	1415	330	255		215
90-30	865	1440	360	285		252
90-40-2	957	1607	400	310		312
90-40	957	1607	400	310		312
90-50-2	1049	1699	400	310		336
90-50	1049	1699	400	310		336
90-60-2	1141	1826	460	340	407	
90-60	1141	1826	460	340	407	

PV 30

2900 об/мин

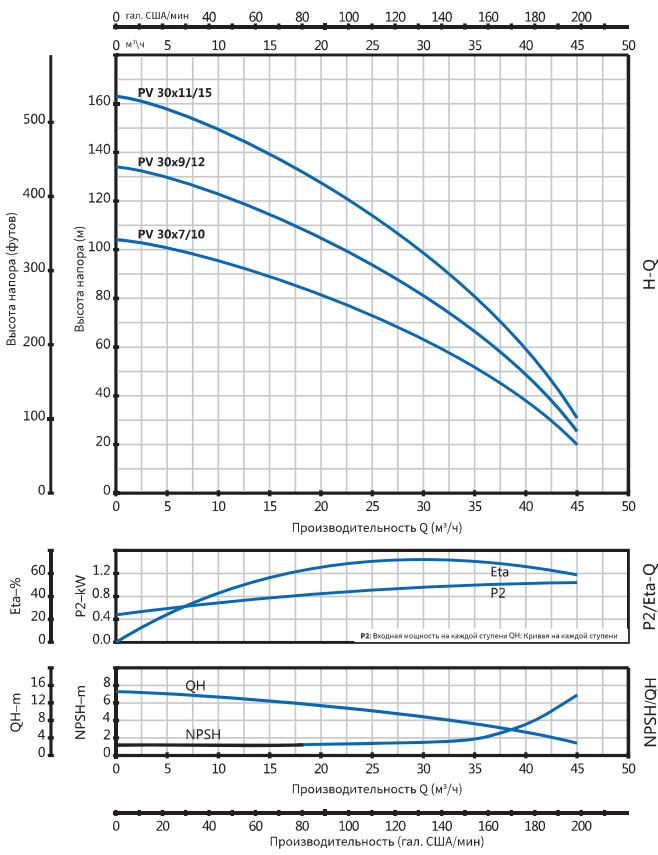

PVT(S)1

2900 об/мин

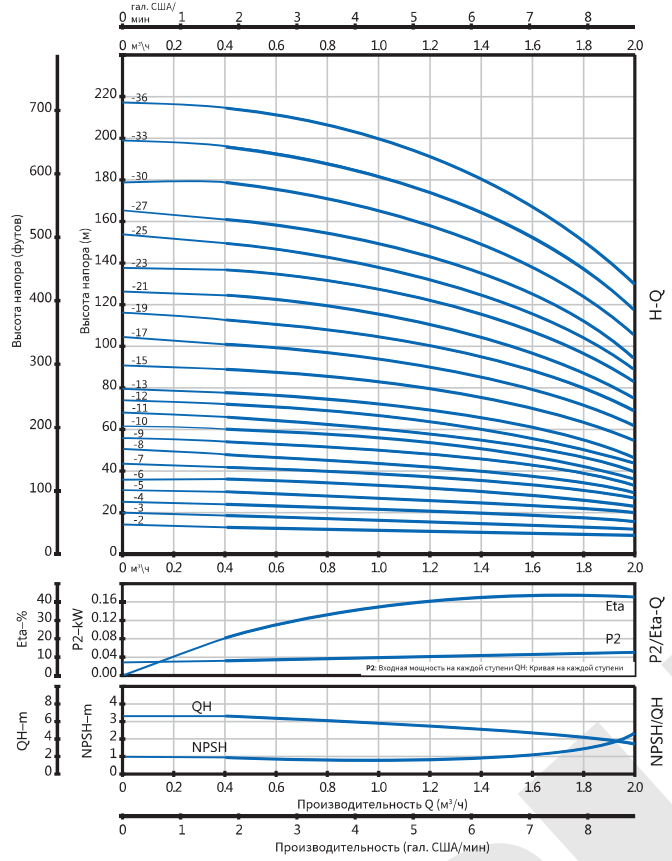

PVT(S)2

2900 об/мин

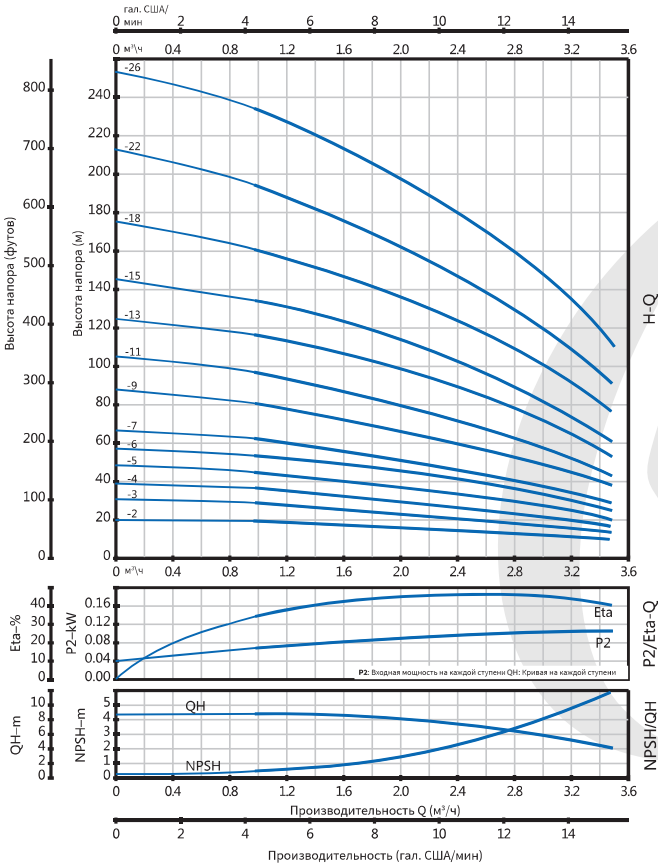

PVT(S)3

2900 об/мин

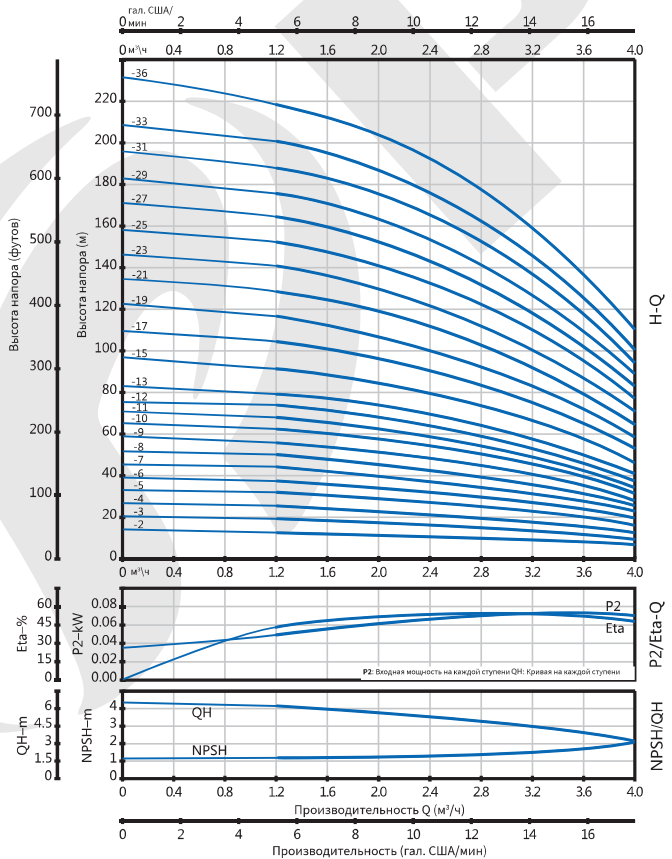

PVT(S)4

2900 об/мин

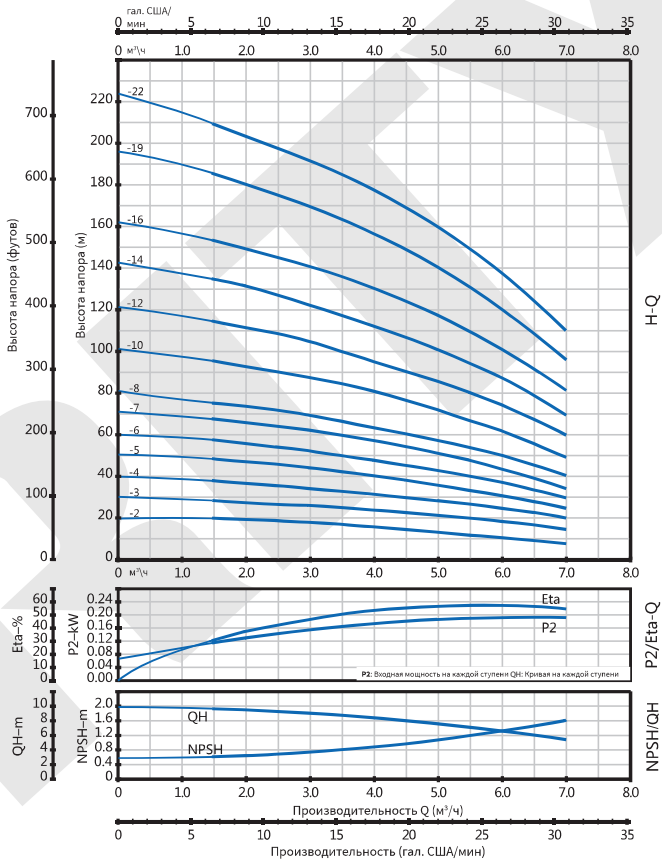

PVT(S)8

2900 об/мин

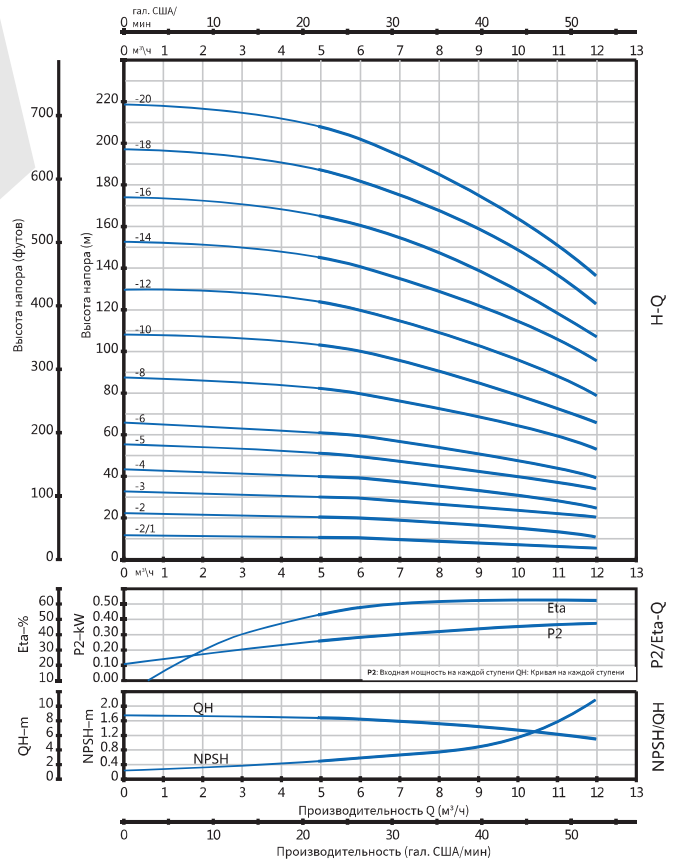

PVT(S)10

2900 об/мин

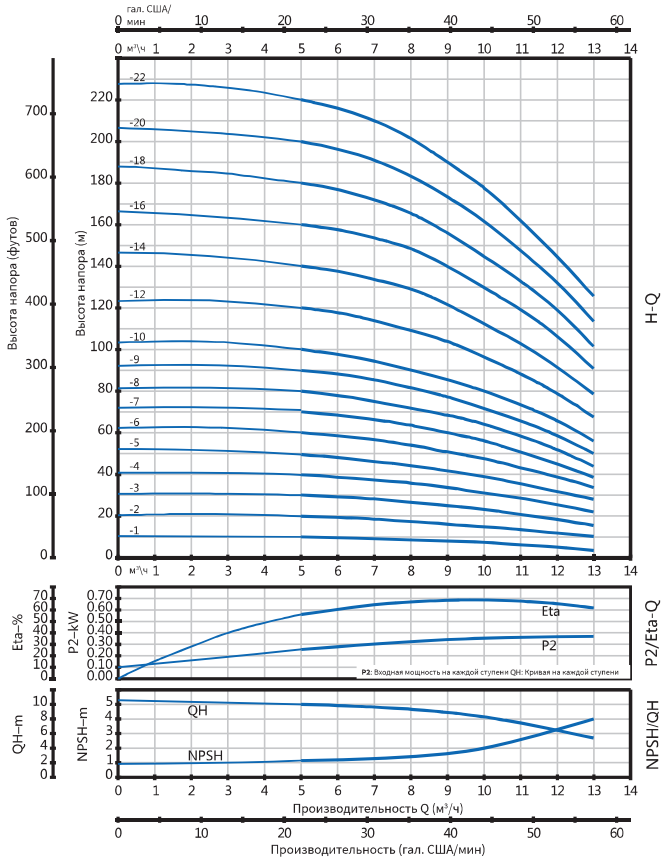

PVT(S)12

2900 об/мин

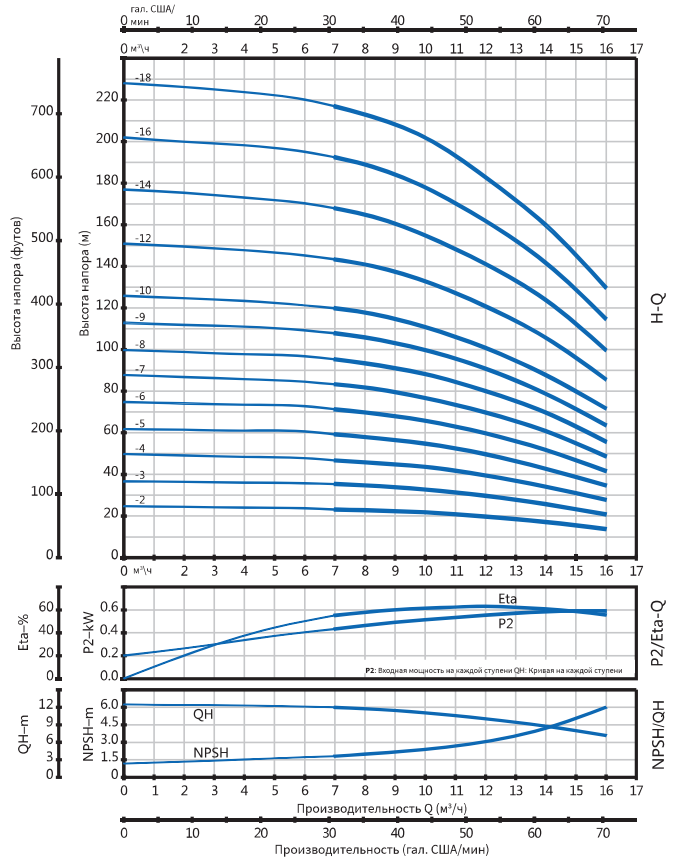

PVT(S)16

2900 об/мин

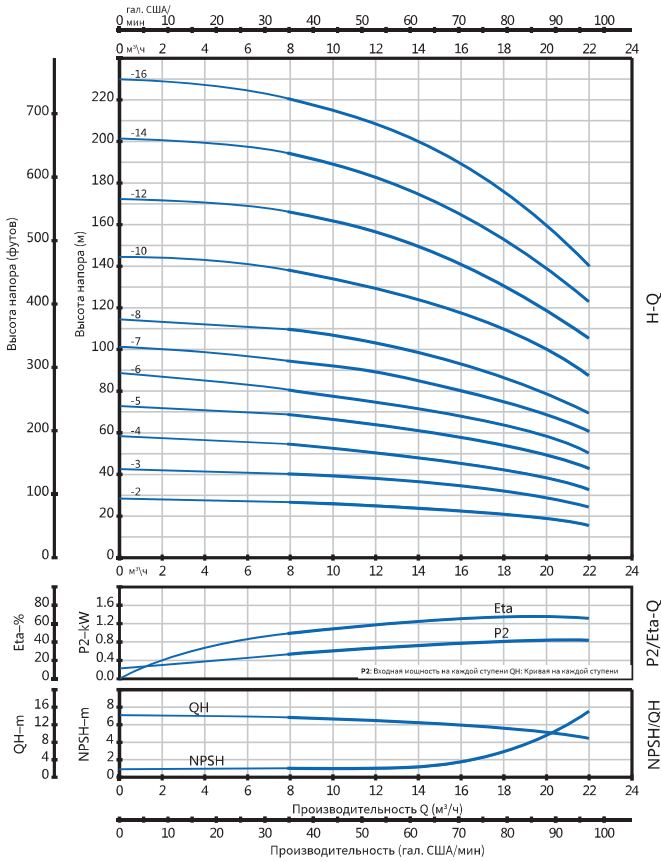

PVT(S)20

2900 об/мин

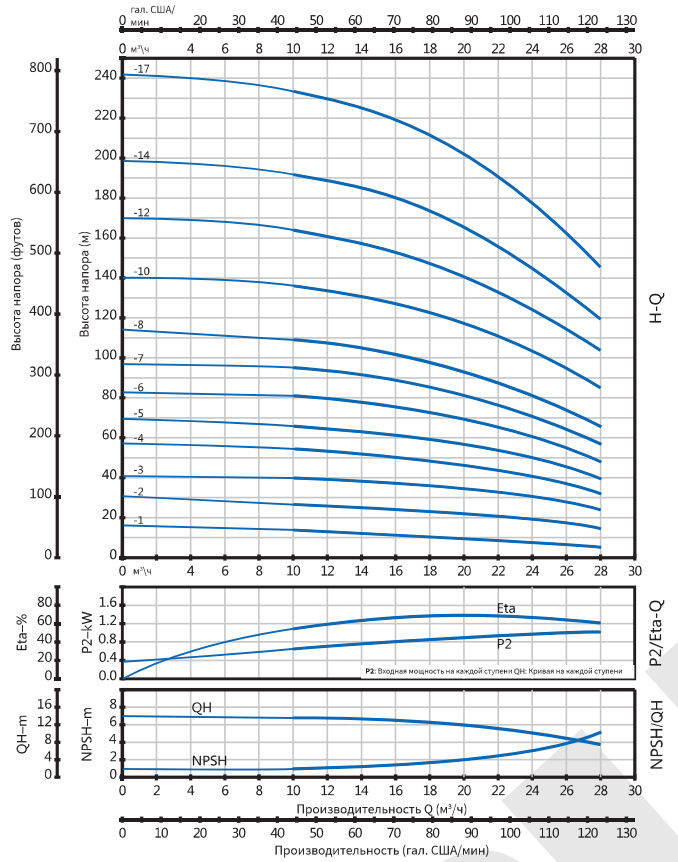

PVT(S)32

2900 об/мин

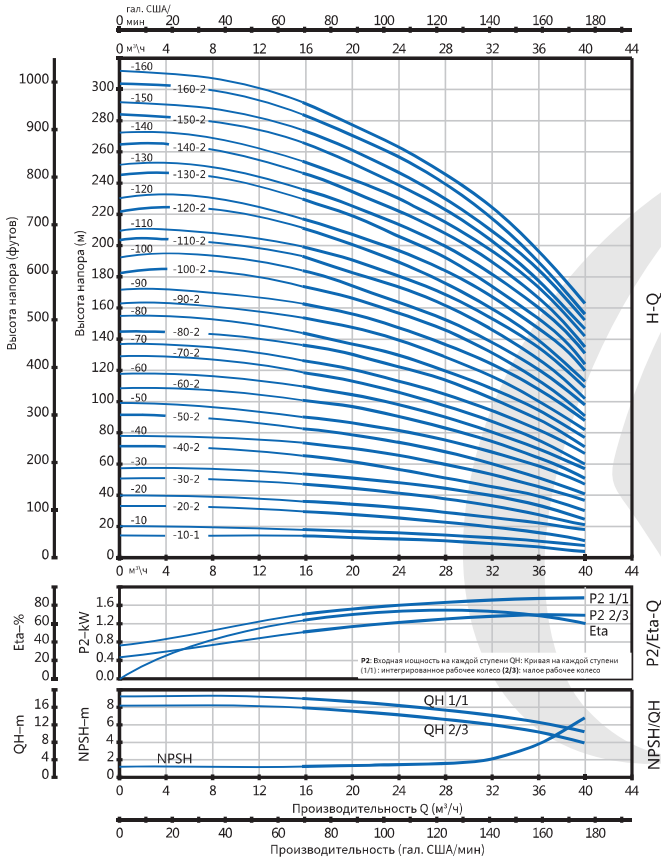

PVT(S)45

2900 об/мин

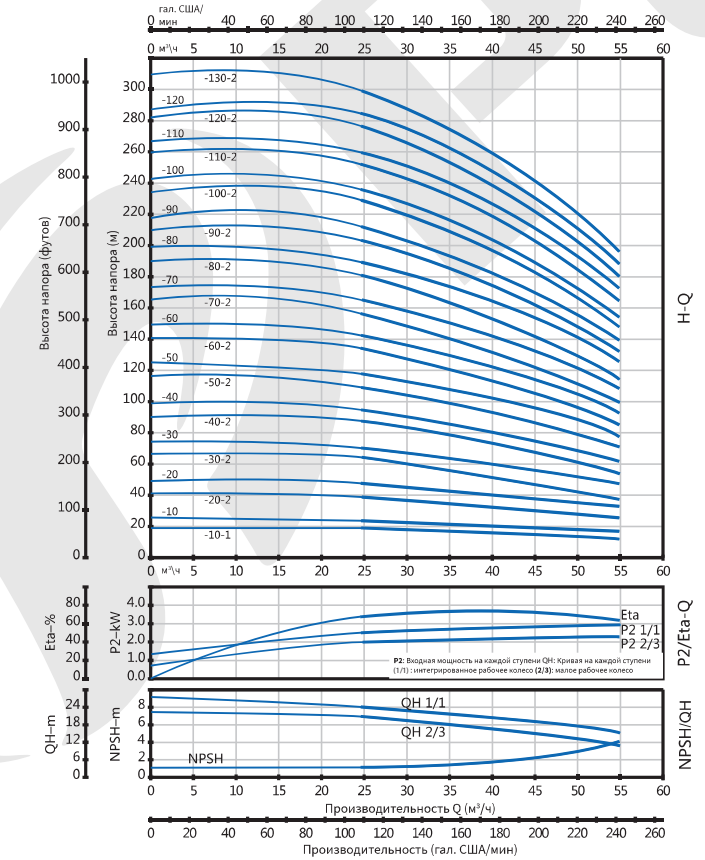

PVT(S)64

2900 об/мин

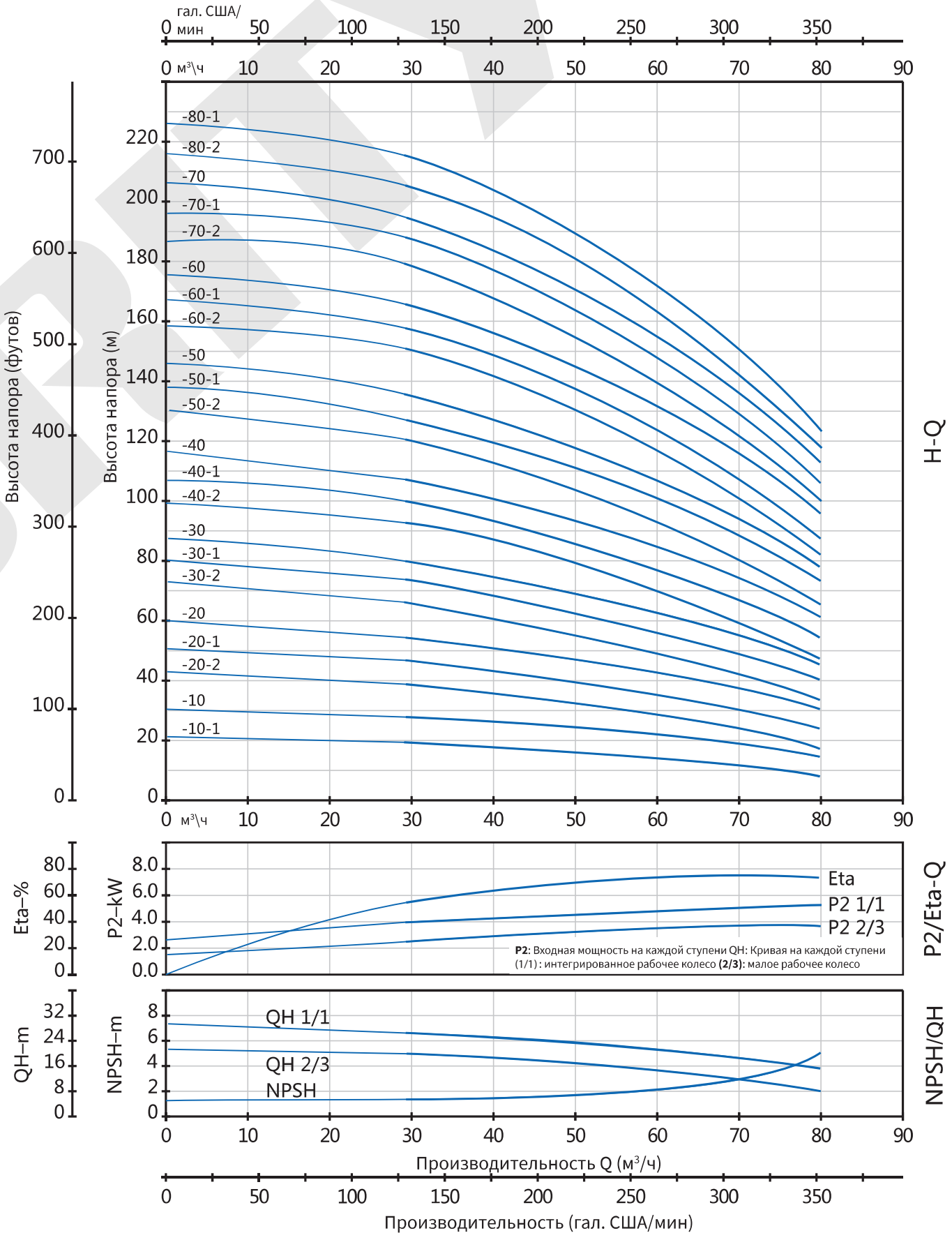

PVT(S)90

2900 об/мин

